

# **IWAKI Magnetic Drive Pump**

---

## **MD-F type**

---

### **Instruction Manual**

---

 Read this manual before use of product

Thank you for selecting an Iwaki MD-F type Magnetic Drive Pump. This instruction manual deals with "Safety Instructions", "Outline", "Installation", "Operation" and "Maintenance" sections.

Please read through this instruction manual to ensure the optimum performance, safety and service of your pump.

## Contents

<b>Safety Instructions</b> .....	<b>1</b>
<i>Outline</i>	
1. Unpacking & Inspection .....	3
2. Operating principle .....	3
3. Specification & Identification code .....	4
4. Outer dimensions .....	5
5. Performance curves .....	6
6. Overview & Label .....	6
7. Part names & Structure .....	7
<i>Installation</i>	
1. Before installation .....	8
2. Installation/Piping/Electrical wiring .....	11
<i>Operation</i>	
1. Before operation .....	15
<i>Maintenance</i>	
1. Troubleshooting .....	17
2. Maintenance & Inspection .....	17



*This instruction manual should be kept on hand by the end user for quick reference.*

*Contact us or your nearest dealer if you have any questions.*



## Important Instruction

### For the Safe and Correct Handling of the Pump

- "Safety Instruction" section deals with important details about handling of the product. Before use, read this section carefully for the prevention of personnel injury or property damage.
- Observe the instructions accompanied with "WARNING" or "CAUTION" in this manual. These instructions are very important for protecting pump users from dangerous situations.
- The symbols on this instruction manual have the following meanings:

 <b>WARNING</b>	<b>Nonobservance or misapplication of the contents of "Warning" section could lead to a serious accident which may result in death.</b>
 <b>CAUTION</b>	<b>Nonobservance or misapplication of the contents of "Caution" section could lead to a personal injury or damage to the product.</b>

### Types of Symbols

	Indicates a prohibited action or procedure. Inside or near this circle, a concrete and practical image of the activity to be avoided is depicted.
	Indicates an important action or procedure which must be performed or carried out without fail. Failure to follow the instructions herein can lead to malfunction or damage to the pump.

### For exportation

Technology related to the use of goods in this instruction manual falls in the category of technology contained in the Foreign Exchange Order Attachment, which includes complementary export control of technology. Please be reminded that export license, which is issued by the Ministry of Economy, Trade, and Industry could be required, when this is exported or provided to someone even in Japan.

# Safety Instructions

## WARNING

- **Turn off the power.**

Risk of electrical shock. Dismantling/assembling the pump unit without turning off the power may cause an electrical shock. Before engaging in any maintenance or inspection work, be sure to turn off the pump and related devices.



Power off

- **Terminate operation.**

On sensing any abnormality, stop operation immediately and inspect/solve problems.



- **For specified application only**

The use of the pump in any application other than those clearly specified may result in injury or damage. Use the pump in a specified condition.



Prohibited

- **No dismantlement/modification**

Do not dismantle/modify the pump. We are not responsible for any accidents or damage due to modification.



No modification  
No dismantlement

- **Wear protective clothing.**

Always wear protective clothing such as safety goggles and protective gloves during pipework or dismantlement.



Wear protectors

## CAUTION

- **Restriction on operator**

The pump should be handled by a qualified person with a full understanding.



Prohibited

- **Specified power only**

Do not apply any power other than the specified one on the nameplate. Otherwise damage or fire may result.



Prohibited

- **Do not wet the pump.**

If a liquid spills over electric parts or wires, a fire or electrical shock may result. Install the pump in a place free from liquid spillage.



Prohibited

- **Ventilation**

Poisoning may result when handling a toxic or odorous liquid. Keep good ventilation in a work area.



Caution

- **Countermeasure against efflux**

Take a protective measure against the accidental efflux caused by pump or pipe breakage.



Caution

- **Damaged pumps.**

Do not use any damaged pump. Using a damaged pump may lead to an electric leak or shock.



Prohibited

# Safety Instructions

## CAUTION

- **Do not place the pump close to water.**  
The pump is not dust-/water-proof construction. The use of the pump in a humid place or a place where the pump can get wet may result in electrical shock or short-circuit.
- **Do not damage the power cable.**  
Risk of fire or electrical shock. Do not scratch, modify, or pull the power cable. The cable can also be damaged when it is heated or loaded with a heavy thing.
- **Do not cover the motor during operation.**  
Or heats builds up and fire or mechanical failure may result.
- **Earthing**  
Risk of electrical shock. Always earth the pump.
- **Install an earth leakage breaker.**  
An electrical failure of the pump may adversely affect related devices. Purchase and install an earth leakage breaker separately.
- **Power cable is not replaceable.**  
Do not use any damaged power cable for the prevention of a fire or electrical shock. The cable is not replaceable, so that the whole pump unit needs to be replaced when the cable is damaged.



## CAUTION

- **Limited operating site and storage**  
Do not install or store the pump in the following places where...
  1. Ambient temperature exceeds 40°C or falls below 0°C.
  2. Under a flammable/corrosive atmosphere.
- **Do not drain a harmful chemical liquid directly on the ground or the floor.**  
Use a container.
- **Disposal of the used pump**  
Dispose of any used or damaged pump in accordance with relevant regulations. Consult a licensed industrial waste products disposing company.
- **Static electricity**  
When low electric conductivity liquids such as ultra-pure water and fluor inactive liquid (e.g. Fluorinert™) are handled, the static electricity may generate in the pump and may cause static discharge. Take counter-measures to remove the static electricity.





# Outline

Before use, check the specification, limitation and hazardous nature of the pump.

## 1. Unpacking & Inspection

On unpacking the product, check the following points. If you find any problems, contact your nearest distributor.

1. Check the information on the nameplate such as model, discharge capacity, discharge head and voltage to see that the product is delivered as per order.

Iwaki Magnet Pump 		
MODEL		
MAX.CAPACITY	ℓ /min	
MAX.HEAD	m	
SINGLE PHASE (1Φ) INDUCTION MOTOR CAPACITOR-RUN		
POLES	SPEED	rpm
VOLTAGE	V RATING	CONT.
FREQUENCY	Hz	CAPACITOR μF
CURRENT	A	INSULATION CLASS E
OUTPUT	W	THERMALLY PROTECTED
POWER CONSUMPTION	W	INDOOR USE ONLY
	Year:	
<b>⚠ DO NOT RUN PUMP DRY</b>		
MFG.No.		
<b>IWAKI CO.,LTD.</b> MADE IN JAPAN 		
<small>04-Kanda-Subsidiary Chiyomiya-cho Tokyo Japan</small>		

2. Check for transit damage, deformation, and loose bolts.

## 2. Operating principle

The MD-F is a magnetic drive centrifugal pump. The magnetic force of the motor drives the impeller magnet and rotates the impeller in the pump chamber, where a liquid is transferred from the inlet to outlet.

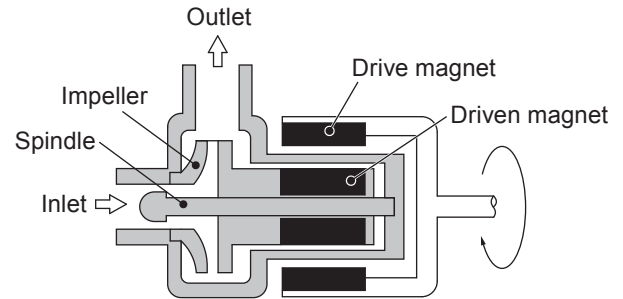

# Outline

## 3. Specification & Identification code

### Identification code

**MD - 15F X - 220 N 01**

a          b          c          d          e

- a. Series model            MD-15F/ -30F/ -55F/ -100F
- b. Impeller type            X, Y, Z
- c. Power voltage            220:                    220/240V (50Hz)
- d. Motor type                N:                        New type motor)
- e. Special version          No code:                Standard  
     01-99:                    Special design

**MD - 55F X - 01**

a          b          c

- a. Series model            MD-55F/ -100F
- b. Impeller type            X, Y, Z
- c. Special version          No code:                Standard  
     01-99:                    Special design

NOTE: Special design is different from standard in power cable length, outlet direction, plug shape or terminal treatment.

### Specification

50/60Hz

Model	Impeller type	Connection	Max flow (L/min)	Max head (m)	Norm flow (m-L/min)	Max SG	Motor		Mass (kg)	Max operating pressure (MPa)
							Power (V)	Rated output (W)		
MD-15FX-220N	X	NPT 1/2	10/-	4.1/-	3-5/-	1.2/-	220/240 (1ph)	10	1.8	0.06
MD-15FY-220N	Y		9/10	3/4	2-5/3-7	1.9/1.3				
MD-15FZ-220N	Z		-/10	-/3.1	-/2.5-6	-/1.9				
MD-30FX-220N	X	NPT 1/2	13/15	8/11	5.5-8/ 8.5-9.5	1.5/1.3	220/240 (1ph)	45	4.0	0.17
MD-30FY-220N	Y		10/12	6/8	4.5-6.5/ 6-8	1.9/1.5				
MD-30FZ-220N	X		-/11	-/7	-/5.5-7	-/1.9				
MD-55FX	X	R1	65/-	7.8/-	6.4-30/-	1.3/-	220/240 (1ph)	90	5.4	0.12
MD-55FY	Y		60/65	5.4/7.8	3.8-30/ /6.4-32	2.0/1.3				
MD-55FZ	Z		-/55	-/6.0	-/4.5-25	-/2.0				
MD-100FX	X	R1	125/-	10.5/-	7.5-65/-	1.2/-	220/240 (1ph) 220/380 (3ph) 400/440 (3ph)	260/-	8.5	0.17
MD-100FY	Y		115/135	8.5/11.5	6-60/ 8-70	2.0/1.3				
MD-100FZ	Z		-/115	-/8.5	-/6.5-55	-/1.9				

### NOTE:

- a. Performance data is based on pumping of clear water at ambient temperature.
- b. The maximum flow is obtained at zero discharge head, and the maximum head is obtained at the maximum pressure.
- c. The maximum viscosity is up to 30mPa\*s (at SG 1.0).
- d. Allowable liquid temperature is 0-80°C.  
     \*Note that the liquid temperature is based on pumping clean water and it changes with liquid property and operating conditions.
- e. Non freezing

f. The maximum specific gravity is obtained at or near the maximum flow. Note that the limitation varies with a duty point, ambient or liquid viscosity.

g. Motor type

MD-15F/-30F/-55F: Single-phase capacitor-run induction motor

MD-100F: Single-phase capacitor-run induction motor or 3-phase induction motor

\*The pump stops when the motor temperature becomes extremely high due to ambient or liquid temperature rise or overload operation. The pump resumes operation after temperature falls to a normal.

\*For the IEC motor, consult your nearest distributor.

## ⚠ CAUTION

- If pump stops frequently, turn off power and check for impeller damage or clogging. See “Troubleshooting” on page 17.
- Do not dismantle the motor. Contact us for inspection.

## 4. Outer dimensions

- MD-15F-N/ -30F-N

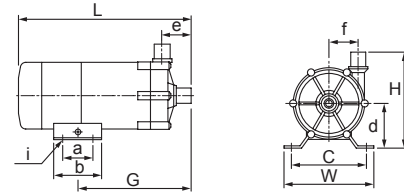

Model	W	H	L	a	b	c	d	e	f	G
MD-15F-N	95	120	186	—	50	68	55	34	28.5	123.5
MD-30F-N	120	130	231	40	64	100	60	39	38.5	152

- MD-55F/ -100F

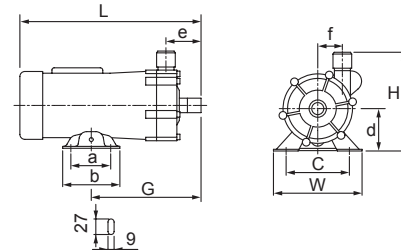

Model	W	H	L	a	b	c	d	e	f	G
MD-55F	120	155	270	40	64	100	65	58.3	39.5	198.5
MD-100F	156	174.3	320	70	100	110	75	63	43	195

## 5. Performance curves

### • MD-15F-N/ -30F-N

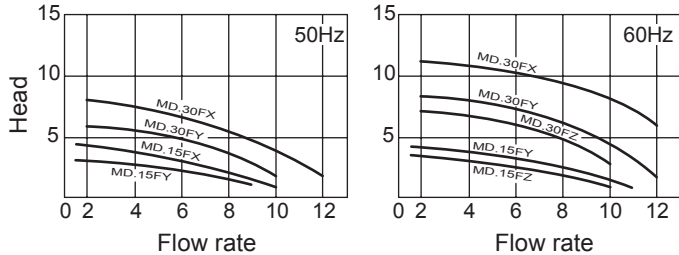

\*Performance data is based on pumping of clear water at ambient temperature.

### • MD-55F/ -100F

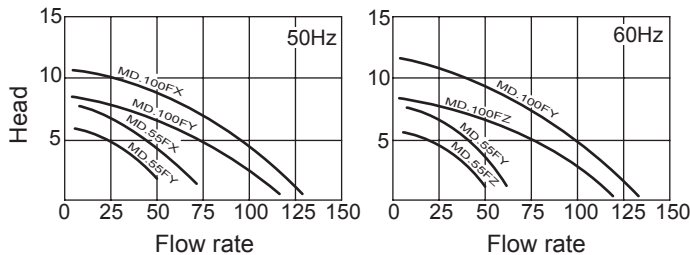

\*Performance data is based on pumping of clear water at ambient temperature.

## 6. Overview & Label

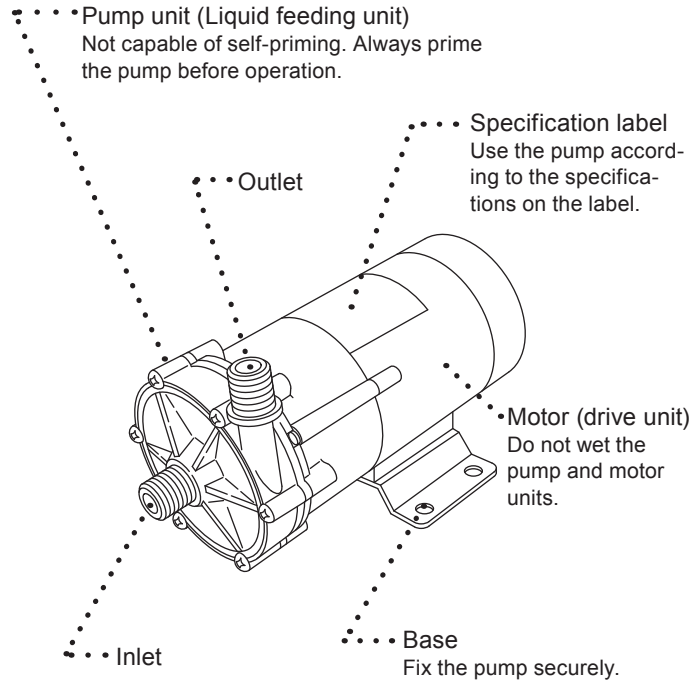



## 7. Part names & Structure

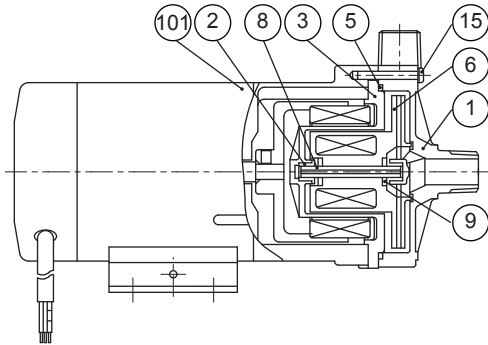

No.	Part names	Q'ty	Materials	Remarks
1	Front casing	1	CFRETFE	
2	Bearing	2	SiC	
3	Rear casing	1	CFRETFE	
5	O ring	1	FKM	
6	Impeller	1	CFRETFE	
8	Spindle	1	SiC	
9	Thrust ring	2	SiC	
15	Machine screw	6	Stainless steel	
101	Motor	1		

# Installation

## 1. Before Installation

Read through this instruction manual before use. Carry out installation work with a full understanding.

### **WARNING**

- Risk of electrical shock. Dismantling/assembling the pump unit without turning off the power may cause an electrical shock. Before engaging in any maintenance or inspection work, be sure to turn off the pump and related devices.
- Electrical work or wiring must be carried out by a qualified person according to local laws or regulations.

### **CAUTION**

- Do not drop the pump.
- A strong magnet is inside the pump. Do not bring a watch or floppy disk which may be adversely affected by a magnetic force.
- Do not run pump dry. If the pump runs without a liquid, friction heat damages the pump.

- Dropping or subjecting the pump to strong impact, failure may result. Handle the pump with care.



- The pump is not capable of self-priming. Always prime the pump before operation.

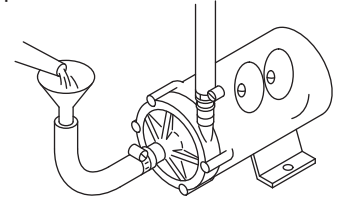

- Allowable liquid temperature range is 0-80°C. Non-freezing. Note the range may change with liquid property.

# Installation

- A strong magnet is inside the pump. Do not use the pump with any liquid which contains metals such as iron and nickel.

## ⚠ CAUTION

Do not install or store the pump in the following places where...

1. Ambient temperature exceeds 40°C or falls below 0°C.
  2. In a dusty/humid place or corrosive atmosphere.
  3. Under direct sunlight or wind & rain.
- Observe the maximum ambient humidity of 90%. The motor is not water-/dust-proof. Do not wet the motor, or it may fail.
  - Banned solutions
    - Halogenated hydrocarbons such as trichloroethylene and carbon tetrachloride
    - Ether and low-grade ester
    - Slurry (Never use slurry, which wears out the pump bearings.)
  - Do not place dangerous or flammable goods near the pump for your safety.

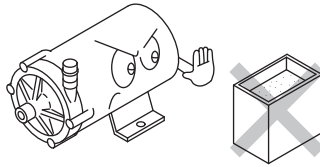

- An electrical failure of the pump may adversely affect related devices. Purchase and install an earth leakage breaker separately.

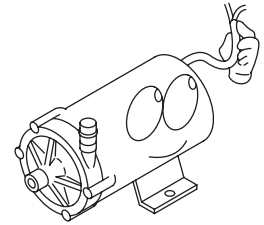

- Non-condensing. Do not wet the motor.

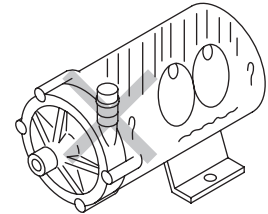

- Do not dismantle/modify the pump. We are not responsible for any accidents or damage due to modification.

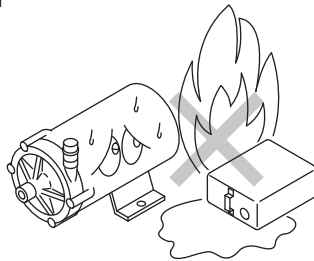

# Installation

- Do not use any damaged pump. Using a damaged pump may lead to an electric leak or shock.
- Do not get the motor wet. The pump is not dust-/water-proof or rust-proof construction.

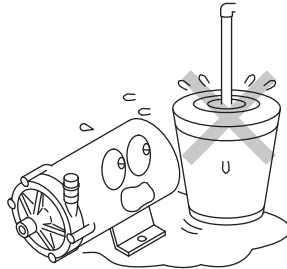

- Risk of fire or electrical shock. Do not scratch, modify, twist or pull the power cable. The cable can also be damaged when it is heated or loaded with a heavy thing. Stop operation and contact us if the power cable is damaged.
- Risk of burning. Do not touch the motor. Motor surface temperature rises high during operation.

- Noise level during operation is as below.

Model	Noise level	Model	Noise level
MD-15FX	55dB	MD-55FX	55dB
MD-15FY		MD-55FY	
MD-15FZ		MD-55FZ	
MD-30FX	60dB	MD-100FX	75dB
MD-30FY		MD-100FY	
MD-30FZ		MD-100FX	

\*Noise level is measured in A scale at a distance of 1m.

# Installation

## 2. Installation/ Piping/ Electrical wiring

*Stop working upon sensing danger or abnormality in work.*

### CAUTION

- **Wear protective clothing.**

Always wear protective clothing such as safety goggles and protective gloves during pipework or dismantlement.

- **A qualified operator only**

The pump must be handled or operated by a qualified person with a full understanding of the pump. Any person who is not familiar with this product should not take part in operation or management.

### 2.1 Installation

#### 1. Installation location

Select a convenient place for maintenance and inspection. Observe the allowable room temperature of 0-40°C and ambient humidity of 90%RH.

#### 2. Mounting position

This pump is not capable of self-priming. Flooded suction application is ideal. The pump should be installed 30cm lower than the suction liquid level, or bearing may be worn soon by entrained air.

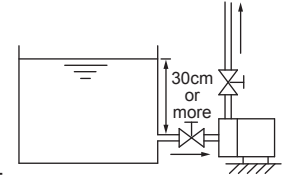

#### 3. Outlet direction

Always direct the outlet upward or entrained air can not be expelled. Do not mount the pump vertically.

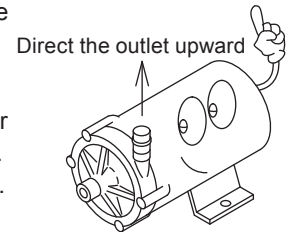

#### 4. Pump fixation

Secure the pump by fixing the base. Do not install the pump vertically.

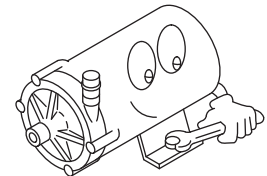

# Installation

## 2.2 Piping

1. In order to minimize the piping resistance, have piping shortest with the minimum bends. For the prevention of cavitation, have the suction piping bore wide as much as possible.
2. Use a corrosion-/pressure-resistant vinyl tube, otherwise the suction hose can be crushed by the suction force (especially for hot liquid). A braided tube or Teflon tube is recommended.

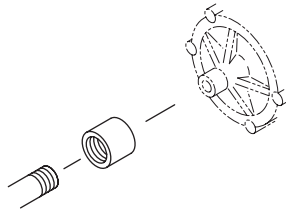

3. For the MD-55F & -100F, be sure to remove a cushion from the outlet before pipework. Be careful not to damage the wet ends, especially SiC parts.
4. Select a suitable tube bore for secure connection.
5. Install valves on both discharge and suction lines.
  - Suction-side valve:  
For easy pump removal and maintenance.
  - Discharge-side valve:  
For adjustment of the flow rate and discharge head.

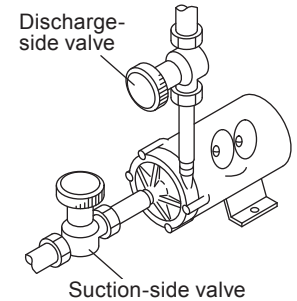

# Installation

## 2.3 Electrical wiring

*Electrical wiring must be done by qualified person who has a full knowledge of safety. We are not responsible for the injury or damage accident due to nonobservance of this warning. Contact us or your nearest distributor for wiring as necessary.*

### ■ Before wiring

1. Confirm that the power is disconnected before work.
2. Wiring work should be done in accordance with electric work requirements. Use the recommended wiring accessories and follow electrical installation requirements.
3. Apply the specified power voltage. See the spec label.
4. The pump doesn't have the ON-OFF switch. The pump starts as the power cable is plugged in.
5. Earth the pump by an earthing wire.
6. When a leakage breaker is used.  
Always solve the root cause when a leakage breaker operates. Replace the fuse and resume operation. Be sure to unplug the pump before investigation.

### ■ Connection diagram

- Single-phase capacitor-run induction motor (MD-15/-30/-50/-100F types)

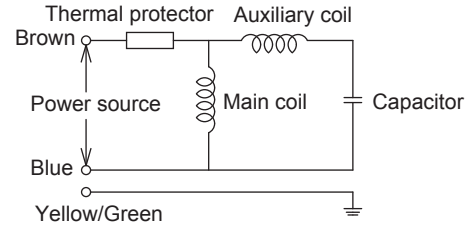

- 220/380V 3-phase motor (MD-100F type)

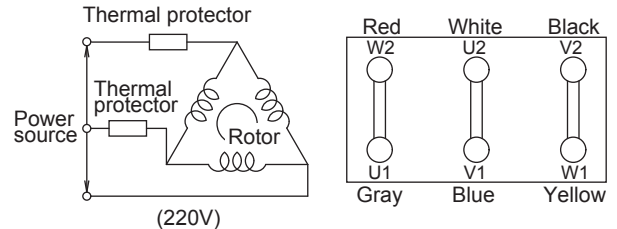

# Installation

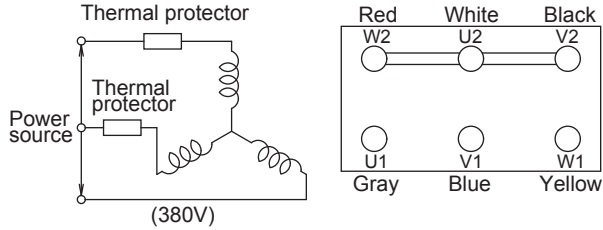

## ■ Rated current & Starting current (50/60Hz)

Model	Rated current			Starting current		
	220/240V Single phase	220/380V 3 phases	400/440V 3 phases	220/240V Single phase	220/380V 3 phases	400/440V 3 phases
MD-15FX-220N	0.18 / -	-	-	0.3 / 0.29	-	-
MD-15FY-220N	0.18 / 0.2	-	-	0.4 / 0.4	-	-
MD-15FZ-220N	- / 0.2	-	-	0.4 / 0.4	-	-
MD-30FX-220N	0.41 / 0.49	-	-	0.4 / 0.4	-	-
MD-30FY-220N	0.37 / 0.37	-	-	1.2 / 1.25	-	-
MD-30FZ-220N	- / 0.32	-	-	1.2 / 1.25	-	-
MD-55FX	1.0 / -	-	-	1.2 / 1.25	-	-
MD-55FY	1.0 / 0.9	-	-	1.1 / 1.0	-	-
MD-55FZ	- / 0.9	-	-	1.1 / 1.0	-	-
MD-100FX	1.93 / -	1.18-0.69 / -	0.62-0.6 / -	3.8-4.3 / -	3.8-2.2 / -	1.9-2.2 / -
MD-100FY	1.93-1.93 / 1.85-1.83	1.18-0.69 / 1.17-0.67	0.62-0.6 / 0.6-0.58	3.8-4.3 / 3.6-4.0	3.8-2.2 / 3.7-2.1	1.9-2.2 / 1.85-2.1
MD-100FZ	- / 1.85-1.83	- / 1.17-0.67	- / 0.6-0.58	- / 3.6-4.0	- / 3.7-2.1	- / 1.85-2.1

- 400/440V 3-phase motor (MD-100F type)

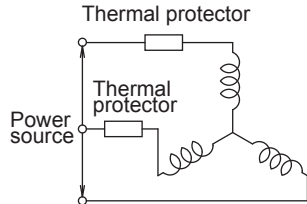



# Operation

## 1. Before operation



### CAUTION

- Before operation, check that the pump is firmly installed in piping via the inlet and outlet and the pump is securely fixed.
- Do not run pump dry. If the pump runs without a liquid, the pump is damaged by friction heat.
- Do not run the pump with a discharge/suction valve closed.
- Do not open the discharge valve or suction valve at once, otherwise the magnetic coupling may disconnect (In this case turn off the power.).

### ■ Operation

After installation, piping and wiring work are completed, operate the pump in accordance with the following procedures.

No.	Procedure	Points to be checked
1	Check piping, wiring and voltage.	<ul style="list-style-type: none"> <li>• See "2.2 Piping" and "2.3 Electrical wiring" sections.</li> <li>• Check the spec label to see if the power supply voltage is correct.</li> </ul>
2	Open or close a valve.	<ul style="list-style-type: none"> <li>• Fully open a suction-side valve.</li> <li>• Fully close a discharge-side valve.</li> </ul>
3	Prime the pump chamber.	<ul style="list-style-type: none"> <li>• Prime the pump with liquid (In suction lift application).</li> </ul>
4	Supply power to the pump.	<ul style="list-style-type: none"> <li>• Check the item 1, 2 and 3. Then turn on power and start the pump.</li> </ul>
5	Adjust discharge capacity & discharge head to specified level.	<p>Open a discharge-side valve gradually till the flow and head reach a specified level. <u>Do not open or close the valve at once.</u></p> <p>Note: Do not keep the discharge-side valve closed more than 1 minute.</p> <p>Note: Check that the pump transfers a liquid without trouble. If there is a problem, turn off the power immediately and solve the cause. See "Troubleshooting" section.</p>

# Operation

No.	Procedure	Points to be checked
6	Points to be checked during operation	<ul style="list-style-type: none"> <li>Do not allow foreign matters to enter the pump. Foreign matters may cause impeller to be locked, hindering liquid circulation. In this case turn off power immediately (Contact us).</li> <li>Turn off power when the leakage breaker operates. Investigate the root cause on the Trouble shooting section of page 17.</li> </ul>

## ■ Shutdown

No.	Procedure	Description
1	Close a discharge-side valve.	Close the discharge-side valve gradually. Do not use the solenoid valve.
2	Turn off power.	Check if the motor stops rotating smoothly as turning off power. If it is not smooth, check the motor. Contact us for detail.

## ■ Before a long period of storage

Remove the liquid from the pump before it is stored for a long time. In addition, run the pump with clean water for 5 minutes every 3 months to prevent the motor bearing from being stuck.

## ■ Drainage

### **WARNING**

- Turn off power before work.
- Always wear protective clothing such as safety goggles and protective gloves during pipework or dismantlement.

### **CAUTION**

- Do not get wet with chemical when removing the hose. Do not wet the motor or electric parts.
- Do not drain a harmful chemical liquid directly on the ground or the floor. Always use a container.

## ■ Procedure

1. Turn off power. Make sure no one turns on the power while working on the pump.
2. Close the discharge- and suction-side valves fully.
3. Place a container under the pump and loosen the hose clamp. Pull out hoses from the inlet and outlet. Be careful not to get wet with chemicals.
4. Unfix and take out the pump.
5. Drain residual chemicals through the inlet. Do not drain a harmful chemical liquid directly on the ground or the floor. Use a container.

# Maintenance

## 1. Trouble shooting

Handling of the pump, maintenance and inspection should be carried out within this instruction manual. Do not handle the pump beyond the descriptions in this manual.

We are not responsible for any personal injury or property damage due to nonobservance of this warning. Contact us or your nearest distributor as necessary.

Phenomenon	The pump does not run.	Poor discharge head	Overcurrent	Noise and vibration problem	Leakage	Measure
Causes						
Wrong wiring	<input type="radio"/>		<input type="radio"/>			Inspect wiring. Rewire as necessary.
Motor failure	<input type="radio"/>		<input type="radio"/>			Contact us.
Air is trapped.		<input type="radio"/>		<input type="radio"/>		Eliminate air.
Air suction from the inlet		<input type="radio"/>		<input type="radio"/>		Check suction piping.
Dry running		<input type="radio"/>		<input type="radio"/>		Prime the pump before operation.
Too high SG or viscosity	<input type="radio"/>	<input type="radio"/>	<input type="radio"/>			Replace with suitable pump.
Impeller magnet hits the rear casing	<input type="radio"/>	<input type="radio"/>	<input type="radio"/>	<input type="radio"/>		Contact us.
Impeller is damaged.	<input type="radio"/>	<input type="radio"/>	<input type="radio"/>	<input type="radio"/>		Contact us.
Foreign matters on the impeller.		<input type="radio"/>	<input type="radio"/>	<input type="radio"/>		Contact us.
O ring is damaged					<input type="radio"/>	Contact us
Pump head mounting screws are loose.		<input type="radio"/>			<input type="radio"/>	Tighten the mounting screws.

## 2. Maintenance & Inspection

### WARNING

- Always wear protective clothing such as safety goggles and protective gloves during pipework or dismantlement.

### CAUTION

- Do not get wet with chemical when removing the hose. Do not wet the motor or electric parts.
- Do not drain a harmful chemical liquid directly on the ground or the floor. Always use a container.

### ■ Retightening

After a long period of operation or storage, the pump head mounting screws may be loose. Tighten the mounting screws as necessary, but then do not deform the plastic pump head.

### ■ Daily inspection

Always check for abnormality in vibration, noise, current value, and discharge capacity. Stop operation on sensing any abnormality. And solve problems on the trouble shooting section.

# Maintenance

## ■ Wear parts

- Replace wear parts before the end of estimated life.
- The estimated life is calculated based on the continuous operation with ambient temperature clean water and changes with operating conditions.
- We are not responsible for damage due to use of slurry.
- Replace O ring with new one every time dismantling the pump despite of the estimated life.

No.	Parts	Estimated life
1	Front casing	10,000hours
3	Rear casing	
5	O ring	
6	Impeller	
101	Motor	

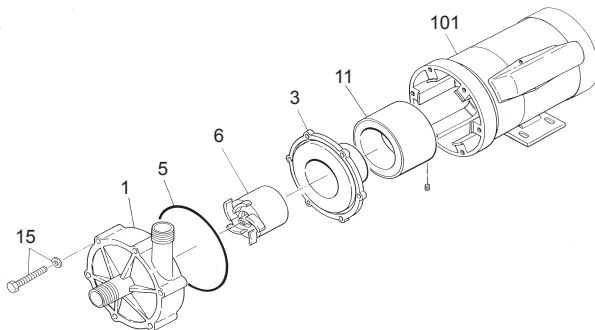



**IWAKI CO.,LTD.** 6-6 Kanda-Sudacho 2-chome Chiyoda-ku Tokyo 101-8558 Japan  
 TEL:(81)3 3254 2935 FAX:3 3252 8892(<http://www.iwakupumps.jp>)

( )Country codes

<b>Australia</b>	<b>IWAKI Pumps Australia Pty. Ltd.</b>	TEL: (61)2 9899 2411	FAX: 2 9899 2421	<b>Italy</b>	<b>IWAKI Italia S.R.L.</b>	TEL: (39)02 990 3931	FAX: 02 990 42888
<b>Austria</b>	<b>IWAKI (Austria) GmbH</b>	TEL: (43)2236 33469	FAX: 2236 33469	<b>Korea</b>	<b>IWAKI Korea Co.,Ltd.</b>	TEL: (82)2 2630 4800	FAX: 2 2630 4801
<b>Belgium</b>	<b>IWAKI Belgium n.v.</b>	TEL: (32)1367 0200	FAX: 1367 2030	<b>Malaysia</b>	<b>IWAKIm Sdn. Bhd.</b>	TEL: (60)3 7803 8807	FAX: 3 7803 4800
<b>China</b>	<b>IWAKI Pumps (Shanghai) Co., Ltd.</b>	TEL: (86)21 6272 7502	FAX: 21 6272 6929	<b>Norway</b>	<b>IWAKI Norge AS</b>	TEL: (47)66 81 1660	FAX: 66 81 1661
<b>China</b>	<b>IWAKI Pumps (Guandong) Co., Ltd.</b>	TEL: (86)750 3866228	FAX: 750 3866278	<b>Singapore</b>	<b>IWAKI Singapore Pte. Ltd.</b>	TEL: (65)6316 2028	FAX: 6316 3221
<b>China</b>	<b>GFTZIWAKI Engineering &amp; Trading (Guangzhou)</b>	TEL: (86)20 8435 0603	FAX: 20 8435 9181	<b>Spain</b>	<b>IWAKI Iberica Pumps, S.A.</b>	TEL: (34)943 630030	FAX: 943 628799
<b>China</b>	<b>GFTZIWAKI Engineering &amp; Trading (Beijing)</b>	TEL: (86)10 6442 7713	FAX: 10 6442 7712	<b>Sweden</b>	<b>IWAKI Sverige AB</b>	TEL: (46)8 511 72900	FAX: 8 511 72922
<b>Denmark</b>	<b>IWAKI Nordic A/S</b>	TEL: (45)48 24 2345	FAX: 48 24 2346	<b>Switzerland</b>	<b>IWAKI (Schweiz) AG</b>	TEL: (41)26 674 9300	FAX: 26 674 9302
<b>Finland</b>	<b>IWAKI Suomi Oy</b>	TEL: (358)9 2745810	FAX: 9 2742715	<b>Taiwan</b>	<b>IWAKI Pumps Taiwan Co., Ltd.</b>	TEL: (886)2 8227 6900	FAX: 2 8227 6818
<b>France</b>	<b>IWAKI France S.A.</b>	TEL: (33)1 69 63 33 70	FAX: 1 64 49 92 73	<b>Taiwan</b>	<b>IWAKI Pumps Taiwan (Hsin-chu) Co., Ltd.</b>	TEL: (886)3 573 5797	FAX: (886)3 573 5798
<b>Germany</b>	<b>IWAKI EUROPE GmbH</b>	TEL: (49)2154 9254 0	FAX: 2154 9254 48	<b>Thailand</b>	<b>IWAKI (Thailand) Co.,Ltd.</b>	TEL: (66)2 322 2471	FAX: 2 322 2477
<b>Holland</b>	<b>IWAKI EUROPE NL Branch</b>	TEL: (31)547 293 160	FAX: 547 292 332	<b>U.K.</b>	<b>IWAKI PUMPS (UK) LTD.</b>	TEL: (44)1743 231363	FAX: 1743 366607
<b>Hong Kong</b>	<b>IWAKI Pumps Co., Ltd.</b>	TEL: (852)2 607 1168	FAX: 2 607 1000	<b>U.S.A.</b>	<b>IWAKI AMERICA Inc.</b>	TEL: (1)508 429 1440	FAX: 508 429 1386
<b>Indonesia</b>	<b>IWAKI Singapore (Indonesia Branch)</b>	TEL: (62)21 690 6606	FAX: 21 690 6612	<b>Vietnam</b>	<b>IWAKI Pumps Vietnam Co.,Ltd.</b>	TEL: (84)613 933456	FAX: 613 933399

T142-2CE-3 '10/07